

WESTON[®]
TOOLS

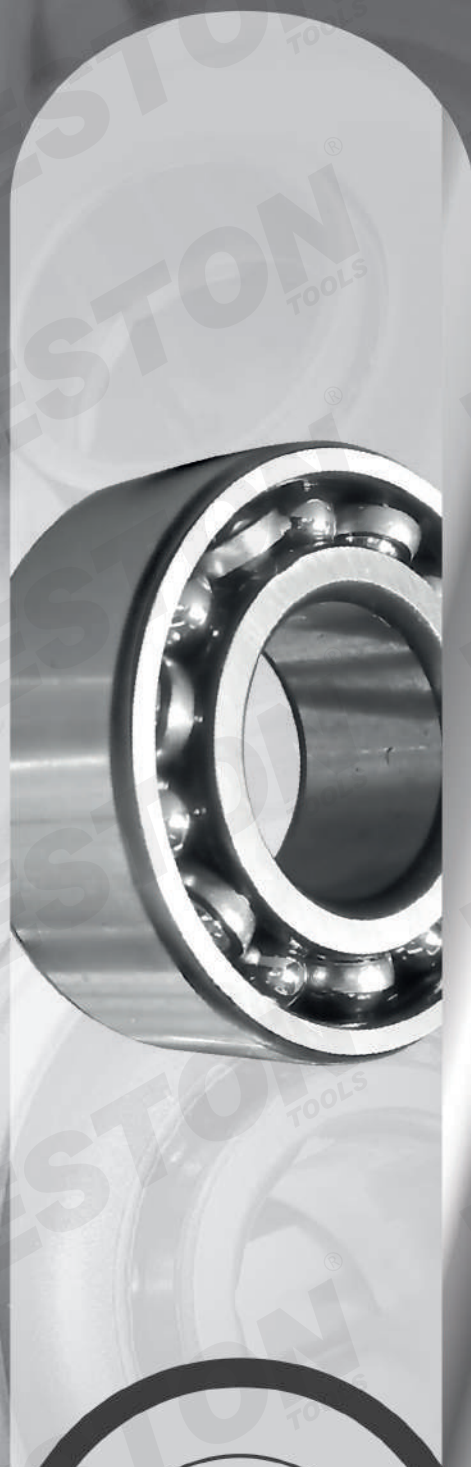

BALEROS

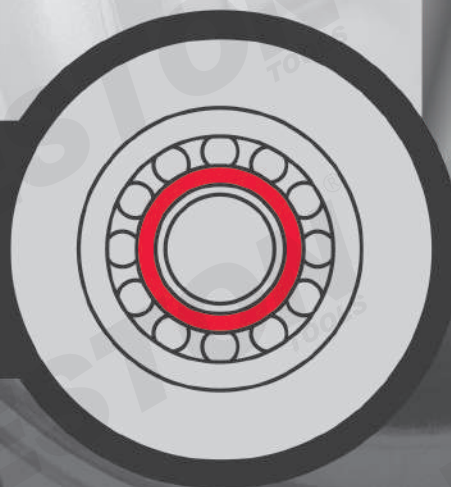

CATÁLOGO **2023**

Balero de Bolas Miniatura

Rodamientos de bolas de una hilera
Soportan cargas radiales y axiales en ambos sentidos y requieren poco mantenimiento

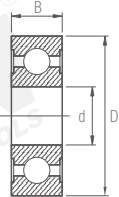

Código	Inoxidable	Modelo	d (mm)	D (mm)	B (mm)
A-10000	A-11842	R2-2RS	3.175	9.525	3.969
A-10005		R2-ZZ	3.175	9.525	3.969
A-10020	A-11844	R3-2RS	4.762	12.7	3.969
A-10025		R3-ZZ	4.762	12.7	3.969
A-10030		R4-ZZ	6.35	15.875	4.978
A-10041		R4A-2RS	6.35	19.05	5.556
A-10042		R4A-ZZ	6.35	19.05	5.556
A-10050	A-11846	R4-2RS	6.35	15.875	4.978
A-10060		RLS4-ZZ	12.7	33.337	9.925
A-10070		RMS4-ZZ	12.7	41.275	15.875
A-10080		R6-ZZ	9.525	22.225	5.556
A-10090	A-11848	R6-2RS	9.525	22.225	5.556
A-10100		RLS6-ZZ	19.050	47.625	14.288
A-10110		R8-ZZ	12.7	28.575	6.35
A-10120	A-11850	R8-2RS	12.7	28.575	6.35
A-10130		RLS8-ZZ	25.4	57.150	15.875
A-10131		RLS8-2RS	25.4	57.150	15.875
A-10140		R10-ZZ	15.875	34.925	7.144
A-10150	A-11852	R10-2RS	15.875	34.925	7.144
A-10160		R12-ZZ	19.05	41.275	7.938
A-10165	A-11854	R12-2RS	19.05	41.275	7.938
A-10170		R14-ZZ	22.225	47.625	9.525
A-10180		R16-ZZ	25.4	50.8	9.525
A-10185	A-11855-00	R16-2RS	25.4	50.8	9.525
A-10190	A-11856	R18-2RS	28.575	53.975	9.525
A-10192		R18-ZZ	28.575	53.975	9.525
A-10200	A-11858	R20-2RS	31.75	57.15	9.525
A-10210	A-11862	R24-2RS	38.1	63.50	11.1125
A-10212		604-ZZ	4	12	4
A-10214		604-2RS	4	12	4
A-10216		606-ZZ	6	17	6
A-10218		606-2RS	6	17	6
A-10220		607-ZZ	7	19	6
A-10230		607-2RS	7	19	6
A-10240		608-ZZ	8	22	7
A-10250		608-2RS	8	22	7
A-10260		609-ZZ	9	24	7
A-10270		609-2RS	9	24	7
A-10272		623-ZZ	3	10	4
A-10273		623-2RS	3	10	4
A-10275		624-ZZ	4	13	5
A-10277		624-2RS	4	13	5
A-10283		625-ZZ	5	16	5
A-10285		625-2RS	5	16	5
A-10290		626-ZZ	6	19	6
A-10295		626-2RS	6	19	6
A-10300		627-ZZ	7	22	7
A-10310		627-2RS	7	22	7
A-10318		628-ZZ	8	24	8
A-10320		628-2RS	8	24	8
A-10330		629-2RS	9	26	8
A-10340		629-ZZ	9	26	8
A-10343		634-2RS	4	16	5
A-10344		636-ZZ	6	22	7
A-10346		634-ZZ	4	16	5
A-10348		686-ZZ	6	13	3.5
A-10350		686-2RS	6	13	3.5
A-10358		688-ZZ	8	16	4
A-10360		688-2RS	8	16	4
A-10370		695-2RS	5	13	4
A-10380		696-2RS	6	15	5
A-10381		696-ZZ	6	15	5
A-10390		697-2RS	7	17	5
A-10392		697-ZZ	7	17	5
A-10394		698-ZZ	8	19	6
A-10396		698-2RS	8	19	6

Balero de Bolas Serie 1000

Código	Inoxidable	Modelo	d (mm)	D (mm)	B (mm)
A-10402		1600-2RS			
A-10405		1601-2RS	0.1875	0.6875	0.2500
A-10410		1602-2RS	0.2500	0.6875	0.2500
A-10420		1603-2RS	7.938	22.225	7.144
A-10425	A-11864	1604-2RS	9.525	22.225	7.144
A-10427		1605-2RS	0.3125	0.9062	0.3125
A-10428		1606-ZZ	9.525	23.019	7.938
A-10430	A-11868	1606-2RS	9.525	23.019	7.938
A-10440		1616-2RS	12.7	28.575	9.525
A-10450	A-11882	1623-2RS	15.875	34.925	11.113
A-10460		1635-2RS	19.050	44.450	12.7
A-10470		1638-ZZ	19.050	50.8	14.288

Balero de Bolas Serie 16000

Código	Modelo	d (mm)	D (mm)	B (mm)
A-10473	16002-2RS	15	32	8
A-10476	16004-2RS	20	42	8

Baleros de Bola Serie 2000

Código	Modelo	d (mm)	D (mm)	B (mm)
A-10479	2213 K	65	120	31

Balero de Bolas Serie 6000

*Presentación con empaque de tubo plástico

Código	Inoxidable	Modelo	d (mm)	D (mm)	B (mm)
A-10800		6000-ZZ	10	26	8
A-10810	A-11888	6000-2RS	10	26	8
A-10815		*6000-2RS	10	26	8
A-10820		6001-ZZ	12	28	8
A-10830	A-11890	6001-2RS	12	28	8
A-10840		6002-ZZ	15	32	9
A-10850	A-11892	6002-2RS	15	32	9
A-10860		6003-ZZ	17	35	10
A-10870		6003-2RS	17	35	10
A-10880		6004-ZZ	20	42	12
A-10890	A-11896	6004-2RS	20	42	12
A-10895		*6004-2RS	20	42	12
A-10900		6005-ZZ	25	47	12
A-10910	A-11898	6005-2RS	25	47	12
A-10915		*6005-2RS	25	47	12
A-10920		6006-ZZ	30	55	13
A-10930		6006-2RS	30	55	13
A-10940		6007-2RS	35	62	14
A-10945		6007-ZZ	35	62	14
A-10950		6008-ZZ	40	68	15
A-10960		6008-2RS	40	68	15
A-10970		6009-ZZ	45	75	16
A-10990		6010-ZZ	50	80	16
A-11000		6010-2RS	50	80	16
A-11001		6011-2RS	55	90	8
A-11003		6012-2RS	60	95	18
A-11004		6012-ZZ	60	95	18
A-11005		6013-ZZ	65	100	18
A-11010		6014-2RS	70	110	20

Balero de Bolas Serie 6200

Rodamientos de bolas de una hilera

Soportan cargas radiales y axiales en ambos sentidos y requieren poco mantenimiento

*Presentación con empaque de tubo plástico

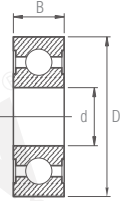

Código	Inoxidable	Modelo	d (mm)	D (mm)	B (mm)
A-11020		6200-ZZ	10	30	9
A-11030	A-11901	6200-2RS	10	30	9
A-11050		6201-ZZ	12	32	10
A-11060	A-11902	6201-2RS	12	32	10
A-11070		6201-2RS (13mm)	13	32	10
A-11080		6201-2RS 1/2"	12.7	32	10
A-11090		6202-ZZ	15	35	11
A-11100	A-11904	6202-2RS	15	35	11
A-11120		6202-ZZ 5/8"	15.87	35	11
A-11140		*6202-2RS	15	35	11
A-11150		6202-2RS 1/2"	12.7	35	11
A-11155		6202-2RS 5/8"	15.87	35	11
A-11157		6202-2RS 16mm	16	35	11
A-11158		6203-ZZ 12mm	12	35	11
A-11160		*6203-ZZ	17	40	12
A-11161		6203-2RS 12mm	12	40	12
A-11170	A-11906	6203-2RS	17	40	12
A-11180		6203-2RS 5/8"	15.87	40	12
A-11185		*6203-2RS 5/8"	15.87	40	12
A-11190		6203-2RS 1/2"	12.7	40	12
A-11195		6203-2RS 3/4"	19.05	40	12
A-11200		6204-ZZ	20	47	14
A-11205		*6204-ZZ	20	47	14
A-11210		6204-2RS	20	47	14
A-11220		6204-2RS 3/4" BORE	19.05	47	14
A-11225		*6205-ZZ	25	52	15
A-11230		6205-ZZ	25	52	15
A-11235		*6205-2RS	25	52	15
A-11240	A-11910	6205-2RS	25	52	15
A-11245		6205-2RS NR con retén	12	32	15.9
A-11250		6205-2RS 1" BORE	25.4	52	15
A-11251		6205-2RS LB P/LAVADORA	25	52	15
A-11251-C		6205-2RS LB P/LAVADORA con cuña	25	52	15
A-11255		*6206-ZZ	30	62	16
A-11260		6206-ZZ	30	62	16
A-11270		6206-2RS	30	62	16
A-11275		*6206-2RS	30	62	16
A-11280		6207-ZZ	35	72	17
A-11290		6207-2RS	35	72	17
A-11295		*6207-2RS	35	72	17
A-11330		6208-ZZ	40	80	18
A-11340		6208-2RS	40	80	18
A-11350		6209-ZZ	45	85	19
A-11360		6209-2RS	45	85	19
A-11370		6209-ZNR	45	85	19
A-11380		6210-ZZ	50	90	20
A-11390		6210-2RS	50	90	20
A-11400		6211-ZZ	55	100	21
A-11410		6211-2RS	55	100	21
A-11415		6212-2RS	60	110	22
A-11420		6212-ZZ	60	110	22
A-11422		6212 C3	60	110	22
A-11430		6213	65	120	23
A-11460		6214 2RS C3	70	125	24
A-11470		6215 2RS C3	75	130	25
A-11480		6216 2RS C3	80	140	26
A-11485		6217-2RS	85	150	28
A-11490		6217 2RS C3	85	150	28

Balero de Bolas Serie 62000

Código	Modelo	d (mm)	D (mm)	B (mm)
A-11040	62000-2RS	10	26	10
A-12052	62202-2RS	15	35	14
A-12054	62203-2RS	17	40	16
A-12056	62204-2RS	20	47	18
A-12058	62205-2RS	25	52	18
A-12059	62302-2RS	15	42	17

Balero de Bolas Serie 6300

*Presentación con empaque de tubo plástico

Código	Modelo	d (mm)	D (mm)	B (mm)
A-11530	6300-ZZ	10	35	11
A-11540	6300-2RS	10	35	11
A-11550	6301-ZZ	12	37	12
A-11045	63001-2RS	12	28	12
A-11560	6301-2RS	12	37	12
A-11570	6302-ZZ	15	42	13
A-11580	6302-2RS	15	42	13
A-11590	6303-ZZ	17	47	14
A-11600	6303-2RS	17	47	14
A-11620	6304-ZZ	20	52	15
A-11630	6304-2RS	20	52	15
A-11670	6305-ZZ	25	62	17
A-11680	6305-2RS	25	62	17
A-11695	*6305-2RS	25	62	17
A-12464	63/22	22	56	16
A-12467	63/28	28	68	18
A-11700	6306-ZZ	30	72	19
A-11710	6306-2RS	30	72	19
A-11730	6307-ZZ	35	80	21
A-11740	6307-2RS	35	80	21
A-11745	6308	40	90	23
A-11750	6308-ZZ	40	90	23
A-11760	6308-2RS	40	90	23
A-11765	6309	45	100	25
A-11770	6309-ZZ	45	100	25
A-11780	6309-2RS	45	100	25
A-11790	6310-ZZ	50	110	27
A-11800	6310-2RS	50	110	27
A-11805	6310-ZNR	50	110	27
A-11810	6311-ZZ	55	120	29
A-11820	6311-2RS	55	120	29
A-11830	6315 2RS C3	55	120	29

Balero de Bolas Serie 6800

Código	Modelo	d (mm)	D (mm)	B (mm)
A-11920	6802-2RS	15	24	5
A-11930	6803-2RS	17	26	5
A-11940	6804-2RS	20	32	7
A-11945	6805-ZZ	25	37	7
A-11950	6805-2RS	25	37	7

Balero de Bolas Serie 6900

Código	Inoxidable	Modelo	d (mm)	D (mm)	B (mm)
A-11960		6901-ZZ	12	24	6
A-11965	A-11911	6901-2RS	12	24	6
A-11975	A-11911-00	6902-2RS	15	28	7
A-11980	A-11911-01	6903-2RS	17	30	7
A-11990	A-11912	6904-2RS	20	37	9
A-12000	A-11913	6905-2RS	25	42	9
A-12010	A-11913-00	6906-2RS	30	47	9

Balero de Contacto Angular

Rodamientos de bolas de una hilera de contacto angular

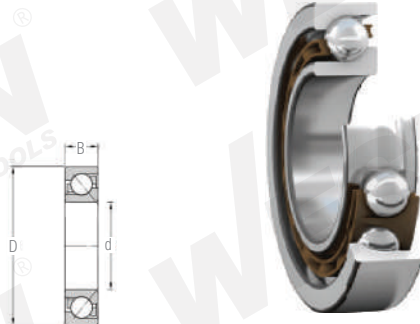

Código	Modelo	Jaula	d (mm)	D (mm)	B (mm)
A-12060	7204-B	Fierro	20	47	14
A-12070	7205-B	Fierro	25	52	15
A-12071	7205-B	Poliamida	25	52	15
A-12080	7206-B	Fierro	30	62	16
A-12081	7206-B	Poliamida	30	62	16
A-12100	7208-B	Fierro	40	80	18
A-12110	7209-B	Fierro	45	85	19
A-12129	7210-2RS	-	50	90	20
A-12130	7210-B	Fierro	50	90	20

Balero de Bolas Serie 3000 y 5000

Rodamientos de dos hileras de bolas de contacto angular
Muy resistentes durante el funcionamiento
Versátiles con una gran variedad de aplicaciones
Soportan cargas radiales y axiales en ambos sentidos

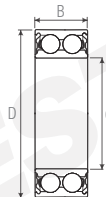

3000			5000			d (mm)	D (mm)	B (mm)
A-10480	3201-2RS		A-10595	5200-ZZ		10	30	14.3
A-10490	3202-2RS		A-10600	5201-2RS		12	32	15.9
A-10500	3203-2RS		A-10605	LR 5201 2RS		12	35	15.9
A-10510	3204		A-10610	5201-ZZ		12	32	15.9
A-10520	3204-2RS		A-10630	5202-ZZ		15	35	15.9
A-10535	3205 c/28 bolas		A-10650	5203-ZZ		17	40	17.5
A-10537	3205 2RS					20	47	20.6
A-10550	3206-2RS		A-10670	5204-ZZ		20	47	20.6
A-10555	3206			5205-2RS		25	52	20.6
A-10560	3207		A-10690	5205-ZZ		25	52	20.6
			A-10710	5206-ZZ		30	62	23.8
						30	62	23.8
			A-10720	5207-2RS		35	72	27
			A-10730	5207-ZZ		35	72	27
			A-10740	5208-ZZ		40	80	30.2
			A-10750	5209-ZZ		45	85	30.2
			A-10760	5210-ZZ		50	90	30.2
			A-10790	5212-ZZ		60	110	36.5
A-10576	3305 c/16 bolas					25	62	25.4
A-10578	3305 c/24 bolas					25	62	25.4
A-10579	3305 c/28 bolas					25	62	25.4

Balero de Bolas de Acero Inoxidable

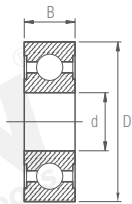

Código	Modelo	d (mm)	D (mm)	B (mm)
A-11833	6203-ZZ 5/8"	17	40	12
A-11840	MR105-2RS	5	10	4
A-11855	R14-2RS	22.225	47.625	9.525
A-11860	R22-2RS	34.925	63.5	11.125
A-11866	1605-2RS	7.938	23.019	7.938
A-11870	1607-2RS	11.113	23.019	7.938
A-11872	1614-2RS	9.525	28.575	9.525
A-11874	1615-2RS	11.113	28.575	9.525
A-11876	1620-2RS	11.113	34.925	11.113
A-11878	1621-2RS	12.7	34.925	11.113
A-11880	1622-2RS	14.288	34.925	11.113
A-11884	1628-2RS	15.875	41.275	12.7
A-11886	1630-2RS	19.050	41.275	12.7

Balero Axial

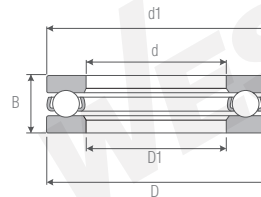

Código	Modelo	d (mm)	D1 (mm)	D (mm)	d1 (mm)	B (mm)
A-12160	51102	15	16	28	28	9
A-12170	51103	17	18	30	30	9
A-12180	51104	20	21	35	35	10
A-12190	51105	25	26	42	42	11
A-12195	51106	30	32	47	47	11
A-12198	51107	35	37	52	52	12
A-12200	51108	40	42	60	60	13
A-12201	51109	45	47	65	65	14
A-12202	51110	50	52	70	70	14
A-12204	51111	55	57	78	78	16
A-12210	51201	12	14	28	28	11
A-12230	51206	30	32	52	52	16
A-12220	51208	40	42	68	68	19
A-12240	51305	25	27	52	52	18
A-12245	51308	40	42	78	78	26
A-12250	51310	50	52	95	95	31
A-12255	51406	30	32	70	70	28

Balero Agrícola con Base



Código	Modelo	Base	Código	Modelo	Base
A-13435	FD209RM	Cuadrada	A-13430	AP28184	Redonda
A-13437	FD211RM	Cuadrada	A-13438	P30942	Redonda
A-13440	ST491A	Cuadrada			
A-13450	ST491B	Cuadrada			
A-13463	ST740	Cuadrada			

Balero de Aguja Agrícola



Código	Modelo
A-13439	SSL-240984R

Balero Agrícola para Arado de Discos

Modelo: 885152

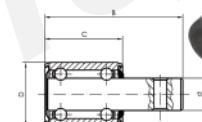

Código	d (mm)	D (mm)	B (mm)	C (mm)
A-13653	15.918	30	69.3	38.9

Repuesto para Chumacera



Balero Agrícola

*Con cubiertas

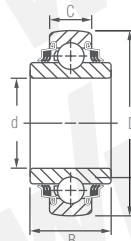

Código	Chumacera compatible
A-15250	CSA204-12 3/4"
A-15280	CSA205-14 7/8"
A-15315	SA205-16 1"
A-15330	CSA205-16 1"
A-15335	CSB205-16 1"
A-15337	SB205 25mm
A-15338	SB205-16 1"
A-15360	CSA206-18 1-1/8"
A-15430	SA207-20 1-1/4"
A-15600	SA210-31 1-15/16"
A-15695	SA206-20
A-15735	ER204-12 3/4"
A-15740	ER16 1"
A-15750	ER19 1-3/16"
A-15755	ER207-20 1-1/4"

Código	Modelo	d (mm)	D (mm)	B (mm)	C (mm)
*A-13460	ST627	55.562	100	55.562	33.34
A-13460-1	ST627	55.562	100	55.562	33.34
A-13462	204FREN	16.052	45.237	18.618	-
A-13463-1	203KRR2	16.256	40	18.29	12
A-13464	203KRR3	15.944	50.787	14.874	-
A-13465	205KRR2	25.65	52	25.40	15
A-13467	205KRRB2	25.65	52	25.40	15
A-13470	W208PPB2	38.113	80	42.96	18
A-13475	205PPB7	23.813	52	34.92	15
A-13480	W208PP5	28.6	80	36.51	18
A-13490	W208PPB5	28.6	80	36.53	18
A-13500	W208PPB6	25.4	80	36.53	18
A-13510	W208PPB7	30.170	80	30.18	18
A-13520	W208PP8	28.6	80	36.51	30.18
A-13530	W208PPB8	28.575	80	36.51	30.18

Código	Modelo	d (mm)	D (mm)	B (mm)	C (mm)
A-13540	W209PPB2	45	85	30.18	30.18
A-13550	W209PPB4	39	85	30.18	30.18
A-13560	W209PPB5	31.8	85	36.53	30.18
A-13570	W209PPB6	38.989	87.325	36.512	30.162
A-13575	W210PPB5	45.340	90	30.18	30.18
A-13580	W210PPB6	28.6	90	36.53	30.18
A-13590	W211PP2	55.580	100	33.34	33.34
A-13600	W211PPB2	55.580	100	33.34	33.34
A-13610	W211PPB3	38.1	100	33.34	33.34
A-13620	W211PPB5	38.1	104.77	44.45	36.53
A-13622	W211PPB20	Para chumacera P30942 (A-13438)			
A-13630	WIR210-31	49.2	90	49.2	20
A-13640	WIR211-33	52.388	100	56.6	21
A-13650	WIR212-39	61.912	110	61.9	22
A-13432	AA28184	44.4	85	40.79	30.16

Balero de Rodillos, Cono y Taza

El balero de cono y taza es el más efectivo para cargas pesadas y de uso continuo. También son ideales para movimientos mecánicos en donde la velocidad y el trato rudo estén presentes.

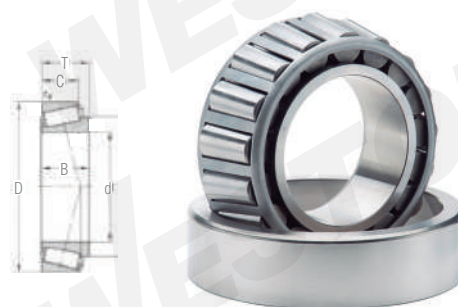

Código	Modelo	d (mm)	D (mm)	T (mm)	B (mm)	C (mm)
A-12258	30202	15	35	11.75	11	10
A-12260	30203	17	40	13.25	12	11
A-12270	30204	20	47	15.25	14	12
A-12280	30205	25	52	16.25	15	13
A-12290	30206	30	62	17.25	16	14
A-12300	30207	35	72	18.25	17	15
A-12310	30208	40	80	19.75	18	16
A-12320	30209	45	85	20.75	19	16
A-12330	30210	50	90	21.75	20	17
A-12335	30302	15	42	14.25	13	22
A-12340	30304	20	52	16.25	15	13
A-12350	30305	25	62	18.25	17	15
A-12360	30306	30	72	20.75	19	16
A-12370	32004X	20	42	15	15	12
A-12380	32207	35	72	24.25	23	19
A-12385	32212	60	110	29.75	28	24
A-12390	32305	25	62	25.25	24	20
A-12395	368S/362	51.5	51.5	51.5	22.22	15.8
A-12400	387A / 382A	57.150	96.838	21.000	21.946	15.875
A-12410	395 / 394A	63.500	110.000	22.000	21.996	18.824
A-12420	482 / 472	69.85	120	29.795	29.007	24.237
A-12440	575/572	76.2	139.9	36.5	36	28.5
A-12445	580 / 572	82.550	139.992	36.512	36.098	28.575
A-12450	594A / 592A	95.25	152.4	39.688	36.322	30.162
A-12460	598A/592A	92	152	39	36.3	30.16
A-12470	2780 / 20	36.487	76.200	23.812	25.654	19.050
A-12480	2788 / 20	38.100	76.200	23.812	25.654	19.050
A-12530	11749 / 10 SET-1	17.462	39.878	13.843	14.605	10.668
A-12540	11949 / 10 SET-2	19.050	45.237	15.494	16.637	12.065
A-12550	12649 / 10 SET-3	21.430	50.005	17.526	18.288	13.970
A-12560	12748 / 10 SET-34	21.430	45.237	15.494	16.637	12.065
A-12570	12749 / 10 SET-12	22.000	45.237	15.494	16.637	12.065
A-12580	12749 / 11 SET-16	22.000	45.975	15.494	16.637	12.065
A-12585	13685 / 21	38.1	69.012	19.05	19.05	15.083
A-12588	14125 / 14276	31.750	69.012	19.845	19.583	15.875
A-12590	15101A / 15245	25.4	62	19.050	20.638	14.288
A-12595	15101 / 15245	25.400	62.000	19.050	20.638	14.288
A-12597	15118 / 15245	30.213	62.000	19.050	20.638	14.288
A-12600	15123 / 245	31.750	62.00	18.161	19.050	14.288

Código	Modelo	d (mm)	D (mm)	T (mm)	B (mm)	C (mm)
A-12605	15580 / 20	26.987	57.150	17.462	17.462	13.495
A-12607	1931 TAZA	-	60.325	-	-	15.875
A-12608	207049A/10	55	95	29	29	-
A-12609	212049 / 11	66.675	122.238	38.100	38.354	29.718
A-12610	25580 / 20 SET-52	44.450	82.931	23.812	25.400	19.050
A-12620	25584 / 20	44.983	82.931	23.812	25.400	19.050
A-12630	25584 / 23	44.983	82.931	26.988	25.400	22.225
A-12640	25590 / 20 SET-54	45.618	82.931	23.812	25.400	19.050
A-12650	25590 / 23 SET-55	45.618	82.931	26.988	25.400	22.225
A-12660	29685 / 20	73.025	112.712	25.400	25.400	19.050
A-12667	29748 / 10	38.100	65.088	18.034	18.288	13.970
A-12670	29749 / 10 SET-70	38.100	65.088	18.034	18.288	13.970
A-12673	3585 / 25	41.275	87.312	30.162	30.886	23.812
A-12675	3780 / 20	50.800	93.264	30.162	30.302	23.812
A-12678	3782 / 20	44.450	93.264	30.162	30.302	23.812
A-12680	39590 / 39520	66.675	112.712	30.162	30.162	23.812
A-12690	44643 / 10 SET-14	25.400	50.292	14.224	14.732	10.668
A-12695	44649 / 10 SET-4	26.987	50.292	14.224	14.732	10.668
A-12697	45291 / 45220	57.150	104.775	30.162	30.958	23.812
A-12700	45449 / 10 SET-8	29.000	50.292	14.224	14.732	10.668
A-12710	47686 / 47620	82.550	133.350	33.338	33.338	26.195
A-12720	48548 / 10 SET-5	34.925	65.088	18.034	18.288	13.970
A-12770	67048 / 10 SET-6	31.750	59.131	15.875	16.764	11.811
A-12780	68149 / 10 SET-13	34.987	59.131	15.875	16.764	11.938
A-12790	68149 / 11 SET-17	34.987	59.975	15.875	16.764	11.938
A-12800	69349 / 10	38.000	63.000	17.000	17.000	13.500
A-12820	86647 / 10	28.575	64.292	21.433	21.433	16.670
A-12825	86649 / 10	30.162	64.292	21.433	21.433	16.670
A-12860	501349 / 10 SET-45	41.275	73.431	19.558	19.812	14.732
A-12870	501349 / 14	41.275	73.431	21.430	19.812	16.604
A-12872	3767 / 20	52.388	93.264	30.163	30.302	23.813 (N)
A-12874	13685 / 13620	38.100	69.012	19.050	19.050	15.083 (N)
A-12876	603049 / 11	45.242	77.778	19.842	19.842	15.080 (N)
A-12878	24780 / 20	41.275	76.2	22.225	23.02	17.463 (N)
A-12880	104949 / 11	50.800	82.550	21.590	22.225	16.510 (N)
A-12882	18590 / 20	41.275	73.025	16.670	17.463	12.700 (N)
A-12884	88048 / 10	33.338	68.263	22.225	22.225	17.463 (N)
A-12886	U399 / U360L SET-10	39.688	73.025	19.395	22.098	15.265 (N)
A-12888	02474 / 02420	28.575	68.263	22.225	22.225	17.463 (N)

Balero de Aguja

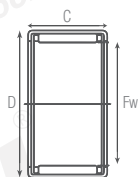

Código	Modelo	Fw (mm)	D (mm)	C (mm)
A-13355	HK0609	6	10	9
A-13356	HK0810	8	12	10
A-13357	HK0910	9	13	10
A-13358	HK1010	10	14	10
A-13359	HK1012	10	14	12
A-13360	HK1210	12	16	10
A-13361	HK1312	13	19	12
A-13362	HK1512	15	21	12
A-13363	HK1516	15	21	16
A-13364	HK1612	16	22	12
A-13365	HK1616	16	22	16
A-13366	HK1622	16	22	22
A-13367	HK1712	17	23	12
A-13368	HK1812	18	24	12
A-13369	HK1816	18	24	16
A-13370	HK2012	20	26	12
A-13371	HK2016	20	26	16
A-13372	HK2020	20	26	20
A-13373	HK2212	22	28	12
A-13374	HK2216	22	28	16
A-13375	HK2512	25	32	12
A-13376	HK2516	25	32	16
A-13377	HK2820	28	35	20
A-13378	HK3012	30	37	12
A-13379	HK3026	30	37	26
A-13380	HK3512	35	42	12
A-13381	HK3516	35	42	16
A-13382	HK4012	40	47	12
A-13383	HK4020	40	47	20
A-13384	HK4520	45	52	20
A-13385	B1612	25.4	31.75	19.05



Balero para Aire Acondicionado

Código	Modelo	d (mm)	D (mm)	B (mm)
A-13020-EB1001	30BG04S8G-2DS	30	47	18
A-13025-EB1004	30BGS10G-2DST	30	52	20
A-13035-EB1006	30BG05SG-2DS	30	55	23
A-13040-EB1014	35BD5220DFX7	35	52	20
A-13045-EB1016	35BG05S10G-2DST2	35	55	20
A-13050-EB1020	38BGD5S2G-2DS	38	54	17
A-13055-EB1023	40BG05S2G-2DS	40	57	24
A-13065-EB1026	40BGS12G-2DS	40	62	20.625
A-13068	40B05S2G-2DS	40	57	24
A-13070-EB1027	40BGS11G-2DS	40	62	24
A-13075	DF0882LB8	40	57	24
A-13080	83A551B4	40	62	24

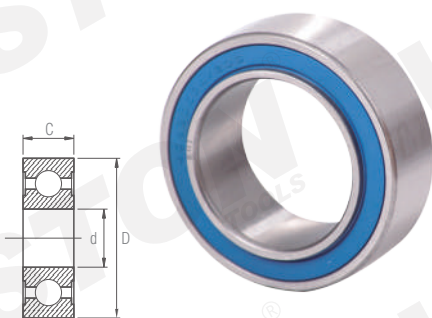

Seguidor de Leva CF

Doble fila de complemento completo
 Agujero hexagonal en ambos lados
 Boquilla de engrase instalada

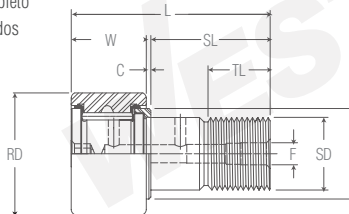

Código	Modelo	RD (mm)	W (mm)	SD (mm)	SL (mm)	C (mm)	TL (mm)	L (mm)	F (mm)	E (mm)
A-13210	CF 1/2" SB	12.70	9.53	4.83	15.9	0.8	6.4	26.2	3.175	10.41
A-13220	CF 5/8" SB	15.88	11.11	6.35	19.1	0.8	7.9	31.0	3.175	11.73
A-13230	CF 3/4" SB	19.05	12.70	9.53	22.2	0.8	9.5	35.7	5	15.48
A-13235	CF 7/8" SB	22.23	12.70	9.53	22.2	0.8	9.5	35.7	5	15.48
A-13240	CF 1" SB	25.40	15.88	11.11	25.4	0.8	12.7	42.1	5	19.84
A-13250	CF 1-1/8" SB	28.58	15.88	11.11	25.4	0.8	12.7	0.8	5	19.84
A-13260	CF 1-1/4" SB	31.75	19.05	12.70	31.8	0.8	15.9	51.6	5	25.00
A-13270	CF 1-3/8" SB	34.93	19.05	12.70	31.8	0.8	15.9	51.6	5	25.00
A-13280	CF 1-1/2" SB	38.10	22.23	15.88	38.1	0.8	19.1	61.1	5	27.78
A-13282	CF 1-5/8" SB	41.28	22.23	15.88	38.1	0.8	19.1	61.1	5	27.78
A-13284	CF 1-3/4" SB	44.45	25.40	19.05	44.5	0.8	22.2	70.6	5	31.75
A-13286	CF 1-7/8" SB	47.63	25.40	19.05	44.5	0.8	22.2	70.6	5	31.75
A-13288	CF 2" SB	50.80	31.75	22.23	50.8	0.8	25.4	83.3	5	35.72

Balero para Montacargas

Proporciona una acción suave al elevar o bajar las horquillas
 Rodamientos guía de mástiles de montacargas

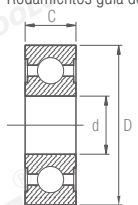

Código	Diámetro	d (mm)	D (mm)	C (mm)
A-12146	MG209MMZ-1	45	100.965	28.4734
A-12148	MG307FFA	35	101.600	30.163
A-12150	MG307-2RS-1	35	101.346	28.575
A-12152	MG307-2RS-2	35	94.615	25.400
A-12154	MG308FFH	40	101.600	28.575
A-12156	309SZZ-9	45	127.063	31.750
A-12158	MG311-2RS-1	55	152.476	38.100



Seguidor de Leva KR

Doble fila de complemento completo
 Agujero hexagonal en ambos lados
 Boquilla de engrase instalada

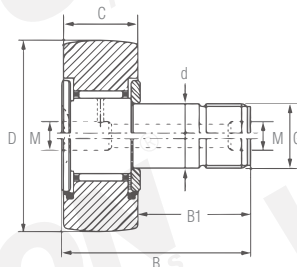

Código	Modelo	D (mm)	d (mm)	C (mm)	B (mm)	B1 (mm)	G (mm)	M (mm)
A-13290	KR 16 PP	16	6	11	28	16	M6 x 1	4
A-13300	KR 19 PP	19	8	11	32	20	M8 x 1.25	4
A-13310	KR 22 PP	22	10	12	36	23	M10 x 1	4
A-13320	KR 30 PP	30	12	14	40	25	M12 x 1.5	6
A-13325	KR 32 PP	32	12	14	40	25	M12 x 1.5	6
A-13330	KR 35 PP	35	16	18	52	32.5	M16 x 1.5	6
A-13340	KR 47 PP	47	20	24	66	40.5	M20 x 1.5	8
A-13350	KR 52 PP	52	20	24	66	40.5	M20 x 1.5	8

Balero Automotriz

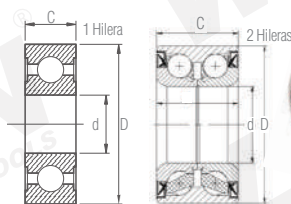

Código	Modelo	Hileras	Compatible	d (mm)	D (mm)	C (mm)
A-12890	539166	2	Dart K	40	76	33
A-13000	15BCD	1	-	15	35	12.7
A-13010	B10-50D	1	Nissan	10	27	11



Rótula Macho POSB

Con balero

Rótula con rosca macho

Superficie esférica del anillo interior con acabado cromado y recubrimiento de zinc platinado en la superficie del cuerpo

Cuerda derecha: A-13148, A-13150, A-13152, A-13154, A-13156, A-13158 y A-13160

Cuerda izquierda: A-13149, A-13151, A-13153, A-13155, A-13157, A-13159 y A-13161

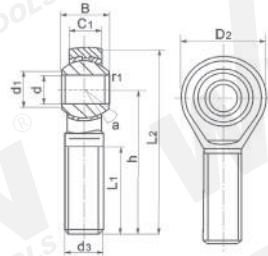

(Dimensiones en mm)

Código	Modelo	Rosca	d	B	r1s	C1 max	d1 min	D2 max	h	L1 min	L2 max	a	Capacidad de carga dinámica (kN)
A-13148	POSB-3	10-32	4.8	7.9	0.3	6.3	7.8	15.8	31.7	19	39.7	10°	3.4
A-13149	POSB-3	10-32	4.8	7.9	0.3	6.3	7.8	15.8	31.7	19	39.7	10°	3.4
A-13150	POSB-4	1/4"-28	6.3	9.5	0.3	7.1	8.4	19	39.6	25.4	49.2	13°	4.5
A-13151	POSB-4	1/4"-28	6.3	9.5	0.3	7.1	8.4	19	39.6	25.4	49.2	13°	4.5
A-13152	POSB-5	5/16"-24	7.9	11.1	0.3	8.7	11.4	22.2	47.6	31.7	58.7	10°	6.9
A-13153	POSB-5	5/16"-24	7.9	11.1	0.3	8.7	11.4	22.2	47.6	31.7	58.7	10°	6.9
A-13154	POSB-6	3/8"-24	9.5	12.7	0.6	10.3	13.1	25.4	49.2	31.7	61.9	9°	9.4
A-13155	POSB-6	3/8"-24	9.5	12.7	0.6	10.3	13.1	25.4	49.2	31.7	61.9	9°	9.4
A-13156	POSB-8	1/2"-20	12.7	15.8	0.6	12.7	17.7	33.3	61.9	38.1	78.5	9°	15
A-13157	POSB-8	1/2"-20	12.7	15.8	0.6	12.7	17.7	33.3	61.9	38.1	78.5	9°	15
A-13158	POSB-10	5/8"-18	15.8	19	0.6	14.2	21.3	38.1	66.6	41.2	85.7	11°	20
A-13159	POSB-10	5/8"-18	15.8	19	0.6	14.2	21.3	38.1	66.6	41.2	85.7	11°	20
A-13160	POSB-12	3/4"-16	19	22.2	0.6	17.4	24.8	44.4	73	44.4	95.2	10°	29
A-13161	POSB-12	3/4"-16	19	22.2	0.6	17.4	24.8	44.4	73	44.4	95.2	10°	29

Rótula Hembra PHSB

Con balero

Rótula con rosca hembra

Superficie esférica del anillo interior con acabado cromado y recubrimiento de zinc platinado en la superficie del cuerpo

Cuerda derecha: A-13161-01, A-13162, A-13164, A-13166, A-13168, A-13170 y A-13172

Cuerda izquierda: A-13161-02, A-13163, A-13165, A-13167, A-13169, A-13171 y A-13173

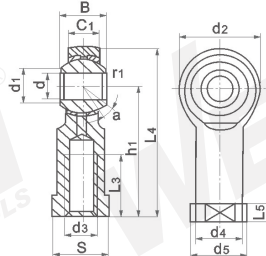

(Dimensiones en mm)

Código	Modelo	Rosca	d	B	r1s	C1 max	d1 min	d2 min	h1	L3 max	L4 max	L5 max	d4 max	d5 max	S	a	Capacidad de carga dinámica (kN)
A-13161-01	POSB-3	10-32	4.8	7.9	0.3	6.3	7.8	15.8	26.9	14.2	34.9	4.7	7.5	10.3	7.9	10°	3.4
A-13161-02	POSB-3	10-32	4.8	7.9	0.3	6.3	7.8	15.8	26.9	14.2	34.9	4.7	7.5	10.3	7.9	10°	3.4
A-13162	POSB-4	1/4"-28	6.3	9.5	0.3	7.1	8.4	19	33.3	29	42.8	4.7	9.1	11.9	9.5	13°	4.5
A-13163	POSB-4	1/4"-28	6.3	9.5	0.3	7.1	8.4	19	33.3	29	42.8	4.7	9.1	11.9	9.5	13°	4.5
A-13164	POSB-5	5/16"-24	7.9	11.1	0.3	8.7	11.4	22.2	34.9	19	46	4.7	10.7	12.7	11.1	10°	6.9
A-13165	POSB-5	5/16"-24	7.9	11.1	0.3	8.7	11.4	22.2	34.9	19	46	4.7	10.7	12.7	11.1	10°	6.9
A-13166	POSB-6	3/8"-24	9.5	12.7	0.6	10.3	13.1	25.4	41.2	23.8	53.9	6.35	13.8	17.4	14.2	9°	9.4
A-13167	POSB-6	3/8"-24	9.5	12.7	0.6	10.3	13.1	25.4	41.2	23.8	53.9	6.35	13.8	17.4	14.2	9°	9.4
A-13168	POSB-8	1/2"-20	12.7	15.8	0.6	12.7	17.7	33.3	53.9	30.1	70.6	6.35	18.6	22.2	19	9°	15
A-13169	POSB-8	1/2"-20	12.7	15.8	0.6	12.7	17.7	33.3	53.9	30.1	70.6	6.35	18.6	22.2	19	9°	15
A-13170	POSB-10	5/8"-18	15.8	19	0.6	14.2	21.3	38.1	63.5	38.1	82.5	7.9	21.8	25.4	22.2	11°	20
A-13171	POSB-10	5/8"-18	15.8	19	0.6	14.2	21.3	38.1	63.5	38.1	82.5	7.9	21.8	25.4	22.2	11°	20
A-13172	POSB-12	3/4"-16	19	22.2	0.6	17.4	24.8	44.4	73	44.4	95.2	7.9	25	28.5	25.4	10°	29
A-13173	POSB-12	3/4"-16	19	22.2	0.6	17.4	24.8	44.4	73	44.4	95.2	7.9	25	28.5	25.4	10°	29

Balero Lineal

Rodamiento lineal (llamado guía de eje) que consta de una jaula polimérica con segmentos de camino de rodadura fabricados en acero templado



Código	Medida	Código	Medida
A-13180	1/4"	A-13188	1"
A-13182	3/8"	A-13190	1-1/4"
A-13184	1/2"	A-13192	1-1/2"
A-13186	5/8"	A-13194	2"
A-13187	3/4"		



Balero 410 para Transportador

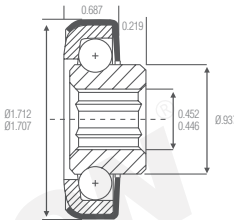

Código	Modelo	Eje	Carga
A-13103	410	Hexagonal	135 kg



Balero 1005 para Transportador

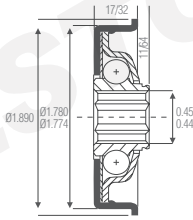

Código	Modelo	Eje	Carga
A-13110	1005	Hexagonal	62 kg



Balero 1107 para Transportador

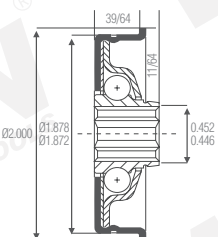

Código	Modelo	Eje	Carga
A-13115	1107	Hexagonal	62 kg



Balero 1274 para Transportador

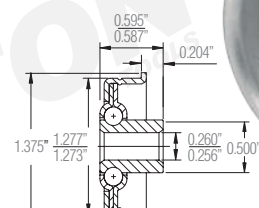

Código	Modelo	Eje	Carga
A-13120	1274	Redondo	20 kg



Balero 1276 para Transportador

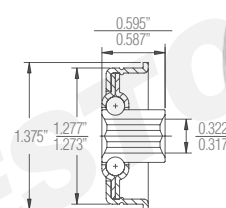

Código	Modelo	Eje	Carga
A-13125	1276	Hexagonal	27 kg



Balero 1500 para Transportador

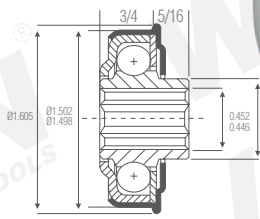

Código	Modelo	Eje	Carga
A-13130	1500	7/16" Hexagonal	64 kg
A-13132	1502	3/8" Hexagonal	64 kg

Balero 1721 para Transportador

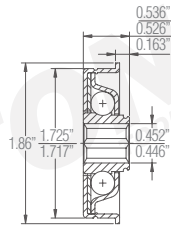

Código	Modelo	Eje	Carga
A-13134	1721	Hexagonal	62 kg

Balero 2500 para Transportador

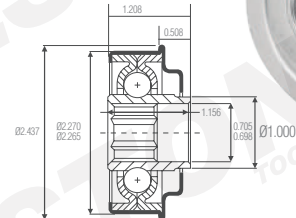

Código	Modelo	Eje	Carga
A-13138	2500	Hexagonal	191 kg

Balero 0016 para Transportador

Capacidad de carga: 45.35 kg
Material acero zincado

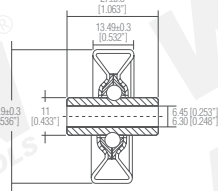

Código	Modelo	Eje	Carga
A-13145	0016	Redondo	44 kg

Balero para Transportador

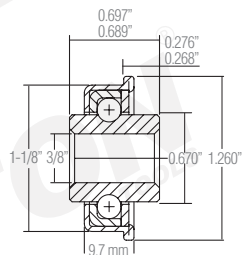

Código	Eje	Carga
A-13105	Redondo	30 kg

Rueda para Transportador

Acero con acabado galvanizado
Cuenta con sello laberíntico que evita que el polvo y partículas entren en los elementos rodantes
No requiere lubricación adicional antes de su uso
Rueda para transportador es una manera rápida, simple y accesible de mover productos



Código	Ancho	Diámetro interno	Diámetro externo	Capacidad
A-13143	5/8"	1/4"	2"	21 kg

Balero MBT para Transportador 9/16"

Para empotrar en agujero de 1"
Acabado galvanizado

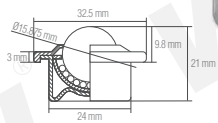

Código	Diámetro de bola	Carga	Material de bola
A-13139	9/16"	15 kg	Acero al carbón

Balero MBT para Transportador 1"

Para empotrar en agujero de 1-13/32"

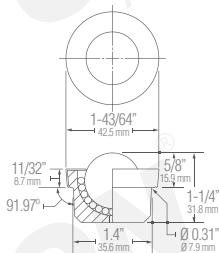

Código	Diámetro de bola	Carga	Material de bola
A-13139-1	1"	90 kg	Acero al carbón

Balero BT-1 para Transportador

Copa de soporte endurecida y galvanizada

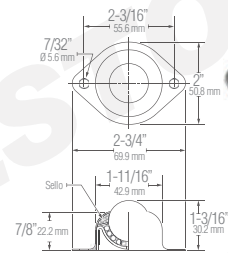

Código	Diámetro de bola	Carga	Material de bola
A-13140	1"	34 kg	Acero al carbón

Balero SBT-1 para Transportador

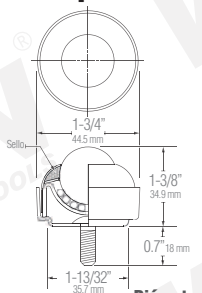

Código	Diámetro de bola	Carga	Material de bola
A-13142	1"	34 kg	Acero al carbón

Balero para Carretilla

Fabricado en acero al carbón

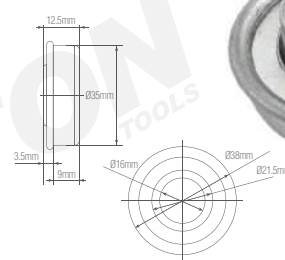

Código	Diámetro interior	Diámetro exterior	Diámetro ext. con ceja	Ancho
A-13100	5/8"	1-3/8"	1-1/2"	1/2"

Balines de Acero

Acero: GCR15
Tensión de rotura: 1667-1814 MPa
Dureza: 61-66 HRC
Rating de dureza: Nivel 2-3



Código	Diámetro	MIN	Código	Diámetro	MIN
A-12132	3/16"	100	A-12138	1/2"	100
A-12133	1/8"	100	A-12140	5/8"	100
A-12134	1/4"	100	A-12142	3/4"	40
A-12136	3/8"	100	A-12144	1"	30